

# EHEIM

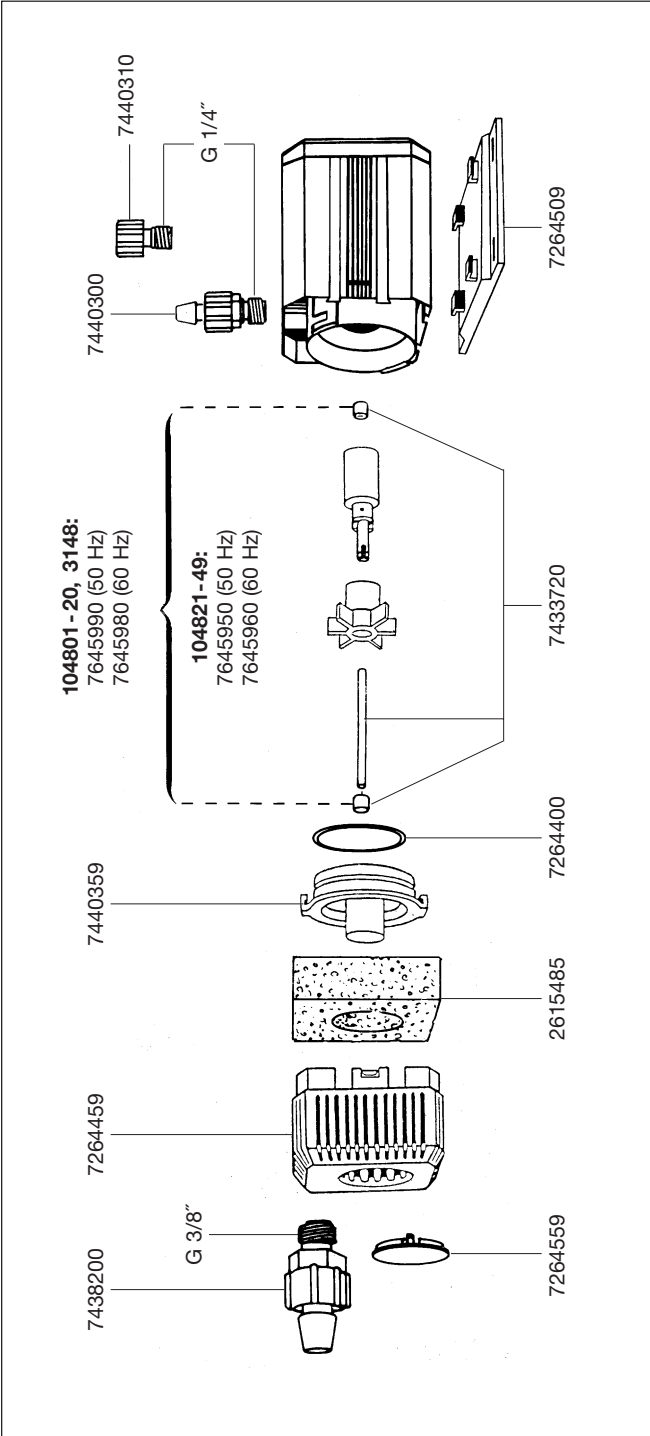

## 1048 3148

<b>Gebrauchsanleitung</b>	<b>D</b>
<b>Instructions</b>	<b>GB / USA</b>
<b>Mode d'emploi</b>	<b>F</b>
<b>Gebruiksaanwijzing</b>	<b>NL</b>
<b>Bruksanvisning</b>	<b>S</b>
<b>Bruksanvisning</b>	<b>N</b>
<b>Käyttöohje</b>	<b>FIN</b>
<b>Brugsanvisning</b>	<b>DK</b>
<b>Istruzioni</b>	<b>I</b>
<b>Instrucciones</b>	<b>E</b>
<b>Návod k použití</b>	<b>CZ</b>
<b>Универсальный насос / насос-фонтан</b>	<b>RUS</b>



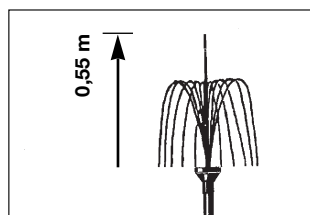
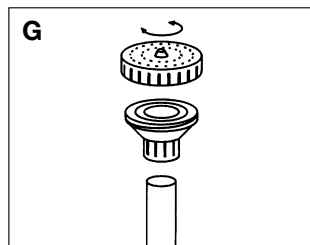
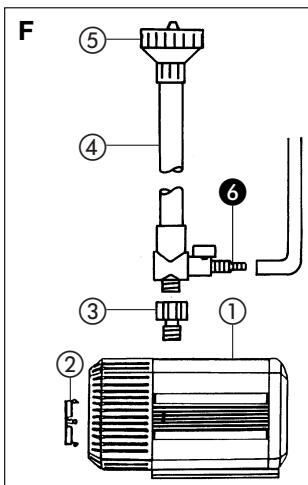
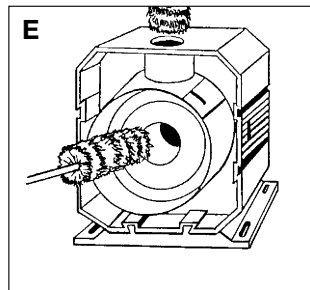
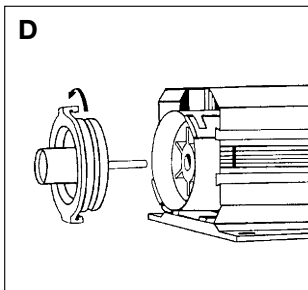
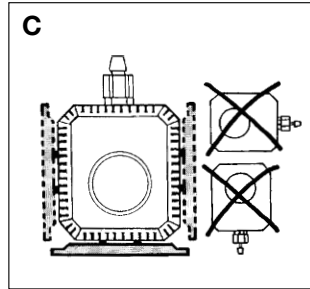
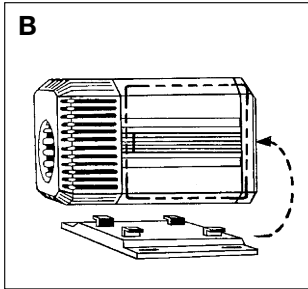
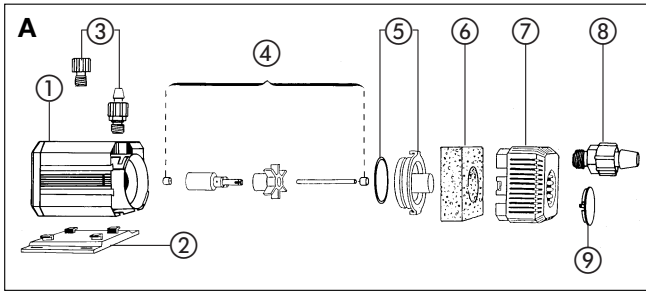

**Vielen Dank**

für den Kauf Ihrer neuen EHEIM Pumpe, die Ihnen optimale Leistung bei höchster Sicherheit und Zuverlässigkeit bietet.

**Sicherheitshinweise**

Bei Wartungs- und Pflegearbeiten sind alle im Wasser befindlichen Elektrogeräte vom Netz zu trennen.



Die Netzanschlussleitung dieses Gerätes kann nicht ersetzt werden. Bei Beschädigung der Leitung darf das Gerät nicht mehr benützt werden. Pumpe niemals am Kabel tragen; Kabel nicht knicken.



Benutzung bei Gartenteichen und in deren Schutzbereich nur zulässig, wenn die Installation den geltenden Vorschriften entspricht. Zum Schutz vor zu hoher Berührungsspannung muss die Installation eine Fehlerstromschutzeinrichtung mit einem Bemessungsreststrom von nicht mehr als 30 mA aufweisen. Bitte fragen Sie Ihren Elektrofachmann.



Dieses Gerät ist nicht dafür bestimmt, durch Personen (einschließlich Kinder) mit eingeschränkten physischen, sensorischen oder geistigen Fähigkeiten oder mangels Erfahrung und/oder mangels Wissen benutzt zu werden, es sei denn, sie werden durch eine für Sicherheit zuständige Person beaufsichtigt oder erhielten von ihr Anweisungen, wie das Gerät zu benutzen ist. Kinder sollten beaufsichtigt werden, um sicherzustellen, dass sie nicht mit dem Gerät spielen.



20 cm  Bei diesen Geräten können Magnetfelder elektronische oder mechanische Störungen oder Beschädigungen hervorrufen. Dies gilt auch für Herzschrittmacher. Die erforderlichen Sicherheitsabstände sind den Handbüchern dieser medizinischen Geräte zu entnehmen.



Bei Wartungsarbeiten besteht Quetschgefahr für die Finger durch hohe Magnetkräfte.



Dieses Produkt nicht mit dem normalen Hausmüll entsorgen. Führen Sie es Ihrer örtlichen Entsorgungsstelle zu.

Das Produkt ist nach den jeweiligen nationalen Vorschriften und Richtlinien approbiert und entspricht den EU-Normen.



**Universalpumpe 1048019 - 1048209**  
– für Freiland geeignet –

Ausführung: siehe Typenschild am Pumpengehäuse

**Funktion**

- A** ① Motorkörper ② Befestigungsplatte ③ Gewindestutzen, druckseitig  
④ Pumpenrad-Set ⑤ Pumpendeckel mit O-Ring ⑥ Grobfilter ⑦ Ansauggitter ⑧ Gewindestutzen, saugseitig ⑨ Verschlussdeckel.

Die Pumpe kann sowohl innerhalb wie außerhalb des Wassers eingesetzt werden. Sie ist nicht selbstansaugend und muss daher bei Betrieb außerhalb unter dem Niveau des Wasserspiegels platziert sein.

**Inbetriebnahme**

Zur Inbetriebnahme am Druck-Schlauchende kurz ansaugen, bis Wasser der Pumpe zufließt. Erst jetzt Netzstecker einstecken. Ein kurzes Anlaufgeräusch der Pumpe ist normal.

Für die Freilandinstallation ist die Pumpe vorschriftsmäßig mit einem 10 m Gummikabel ausgestattet.

Für den Betrieb der Hobbypumpe gibt es verschiedene Einsatzmöglichkeiten: Bei der Verwendung außerhalb des Wassers wird vorzugsweise über den Saugstutzen mit einem Schlauch gearbeitet. Wird die Pumpe innerhalb des Wassers verwendet, darf sie nur über den integrierten Vorfilter betrieben werden. Der Saugstutzen wird dazu herausgedreht und die Ansaugöffnung mit dem beiliegenden Verschlussdeckel abgedeckt.

An der Druckseite stehen wahlweise zwei Anschlussvarianten zur Verfügung: Der Gewindestutzen zur Montage eines Druckschlauches oder ein Adapter für das Steigrohr.

**B/C** Die Befestigungsplatte lässt sich zur universellen Pumpenmontage an die gewünschte Seite versetzen.

### Reinigung und Wartung

**D/E** Netzstecker ziehen. Ansauggitter abnehmen (seitlich leicht zusammendrücken) und Grobfilter unter fließendem Wasser ausspülen.

Bei stark verschmutztem Wasser Grobfilter häufiger reinigen. Ist die Pumpe saug- oder druckseitig stark verschmutzt, führt das zu lauter Geräuschbildung: Ein Zeitpunkt für gründliche Reinigung.

Pumpendeckel entriegeln (**D**) und die Pumpenteile gemäß Zeichnung (**A**) herausnehmen.

Pumpe wie in Bild **E** gezeigt mit dem EHEIM Reinigungsbürsten-Set (Best.-Nr. 4009570) kräftig säubern; Pumpenteile unter fließendem Wasser reinigen. Anschließend in gleicher Reihenfolge wieder zusammensetzen.

### Springbrunnenpumpe 3148010 - 3148200

Ausführung: siehe Typenschild am Pumpengehäuse

### Funktion

**F** ① Pumpe komplett mit Grobfilter ② Verschlussdeckel ③ Adapter ④ Steigrohr ⑤ Düsenkopf.

Die Pumpe saugt grundsätzlich über den integrierter Vorfilter an. Der Adapter an der Druckseite eignet sich zum Anschluss des Steigrohres. Steigrohr in den Adapter einstecken und Düsenkopf aufsetzen.

### Zubehör

**G** Zwischen Adapter und Steigrohr kann ein Speieranschluss (Best.-Nr. 3052400) eingesetzt werden, der die Regulierung der Spritzhöhe erlaubt. Außerdem lässt sich eine Bypass-Schlauchleitung (Best.-Nr. 4003940 oder 4004940) zum Betreiben eines weiteren Wasserspeiers anbringen.

**G** Reinigung des Düsenkopfes: Siehe Zeichnung.

### Universal-Kreiselpumpe 1048219 - 1048499 – nicht für Freiland geeignet –

Ausführung: siehe Typenschild am Pumpengehäuse

Baugleich wie 1048019, jedoch mit 1,7 m PVC-Kabel. Nicht für Freiland geeignet – nicht für Schwimmbecken und Gartenteiche.

## IMPORTANT SAFETY INSTRUCTIONS

**WARNING** – To guard against injury, basic safety precautions should be observed, including the following.

**a) READ AND FOLLOW ALL SAFETY INSTRUCTIONS**

**b) DANGER** – To avoid possible electric shock, special care should be taken since water is employed in the use of aquarium equipment. For each of the following situations, do not attempt repairs by yourself; return the appliance to an authorized service facility for service or discard the appliance.

**1)** If the appliance falls into the water, **DON'T** reach for it! First unplug it and then retrieve it. If electrical components of the appliance get wet, unplug the appliance immediately. (Non-immersible equipment only)

**2)** If the appliance shows any sign of abnormal water leakage, immediately unplug it from the power source. (Immersible equipment only).

**3)** Carefully examine the appliance after installation. It should not be plugged in if there is water on parts not intended to be wet.

**4)** Do not operate any appliance if it has a damaged cord or plug, or if it is malfunctioning or has been dropped or damaged in any manner.

**5)** To avoid the possibility of the appliance plug or receptacle getting wet, position aquarium stand and tank to one side of a wall-mounted receptacle to prevent water from dripping onto the receptacle or plug.

A "drip-loop", shown in the figure, should be arranged by the user for each cord connecting an aquarium appliance to a receptacle.

The "drip-loop" is that part of the cord below the level of the receptacle, or the connector if an extension cord is used, to prevent water traveling along the cord and coming in contact with the receptacle.

If the plug or socket does get wet, **DON'T** unplug the cord. Disconnect the fuse or circuit breaker that supplies power to the appliance. Then unplug and examine for presence of water in the receptacle.

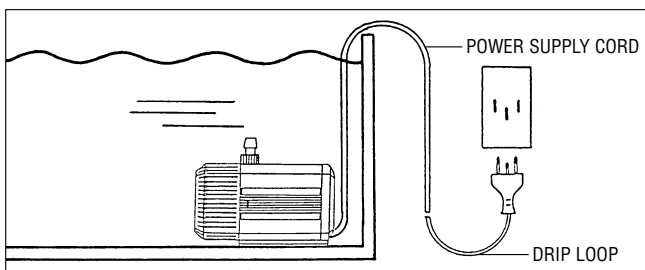

- c)** Close supervision is necessary when any appliance is used by or near children.
- d)** To avoid injury, do not contact moving parts or hot parts such as heaters, reflectors, lamp bulbs, and the like.
- e)** Always unplug an appliance from an outlet when not in use, before putting on or taking off parts, and before cleaning. Never yank cord to pull plug from outlet. Grasp the plug and pull to disconnect.
- f)** Do not use an appliance for other than intended use. The use of attachments not recommended or sold by the appliance manufacturer may cause an unsafe condition.

- g) Do not install or store the appliances where it will be exposed to the weather or to temperatures below freezing.
- h) Make sure an appliance mounted on a tank is securely installed before operating it.
- i) Read and observe all the important notices on the appliance.
- j) If an extension cord is necessary, a cord with a proper rating should be used. A cord rated for less amperes or watts than the appliance rating may overheat. Care should be taken to arrange the cord so that it will not be tripped over or pulled.
- k) This appliance has a polarized plug (one blade is wider than the other). As a safety feature, this plug will fit in a polarized outlet only one way. If the plug does not fit fully in the outlet, reverse the plug. If it still does not fit, contact a qualified electrician. Never use with an extension cord unless plug can be fully inserted. Do not attempt to defeat this safety feature.

*Exception: This instruction may be omitted for an appliance that is not provided with a polarized attachment plug.*

l) **”SAVE THESE INSTRUCTIONS”.**

**WARNING! Risk of electric shock.**

This pump is supplied with a grounding conductor and grounding-type attachment plug. To reduce the risk of electric shock, be certain that it is connected only to a properly grounded, grounding-type receptacle, in a circuit protected by a ground fault circuit interrupter.

**GROUNDING INSTRUCTIONS**

This appliance should be grounded to minimize the possibility of electric shock. This appliance is equipped with an electric cord having an equipment grounding conductor and a grounding-type plug. The plug must be plugged into an outlet that is properly installed and grounded in accordance with all appropriate codes and ordinances.

This appliance is for use on a nominal 120 V circuit, and has a grounding plug that looks like the plug illustrated in Sketch **A**. A temporary adapter which looks like the adapter illustrated in Sketches **B** and **C**, may be used to connect this plug to a two pole receptacle as shown in Sketch **B** if a properly grounded outlet is not available. The temporary adapter should be used only until a properly grounded outlet can be installed by a qualified electrician. The green colored rigid ear (lug, etc.) extending from the adapter must be fastened to a permanent ground such as a properly grounded outlet box.

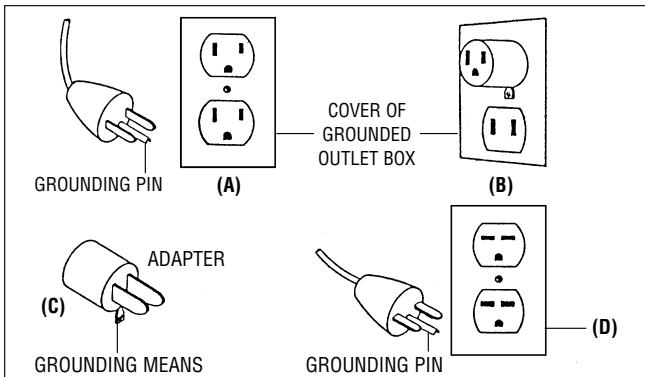

**Thank you**

for purchasing your new EHEIM pump that provides optimum performance with maximum safety and reliability.

**Safety instructions**

All electrical equipment in the water must be disconnected from the mains during care and maintenance work.



The connecting line of this device can not be replaced. When the line is damaged, the device must no longer be used. Never carry the pump by the cable; do not bend the cable.



The pumps may only be used in garden ponds and their area of protection if installed according to prevailing regulations. As a means of protection against overly high shock hazard voltage, the installation must show a leakage current safety guard with a rated residual current of no more than 30 mA. Please consult your electrician.



This equipment is not intended for use by persons (including children) with limited physical, sensory or mental abilities or for persons with no experience or knowledge unless they are supervised by a person responsible for safety or unless they have received from such a person instructions on how to use the equipment.

Children should be supervised to ensure that they do not play with the equipment.



20 cm



**Notice:** These devices produce magnetic fields which might cause electronic and mechanical disturbances or damages. This also refers to pacemakers.

Please consult the manuals of medical equipment for the required safety margins.



**Attention:** Maintenance work presents the risk of crushing the fingers due to high magnetic forces.



Do not dispose of this product as normal household waste. Take it to your local refuse collection site.

The product is qualified in accordance with the respective national regulations and guidelines and meets EC standards.



**Universal Pump 1048019 - 1048209**  
**– suitable for outdoor use –**

Model: see type plate on pump housing

**Function**

- A** ① Motor body ② fixing plate ③ threaded adaptor, pressure side  
 ④ impeller-set ⑤ pump cover with O-ring ⑥ coarse filter ⑦ suction grille ⑧ threaded adaptor, suction side ⑨ cap.

The pump can be used both in and out of the water. It is not self-priming and to operate, must therefore be positioned on the outside of the tank – below the water level.

**Putting into operation**

To make it operate, suck briefly at the end of the pressure hose, until water flows to the pump. Do not insert power supply plug until you have done this.



A brief noise when the pump starts up is normal.

There are several alternatives for using the hobby pump; when used out of the water it is preferable to work through the suction nozzle with a hose. If the pump is used in the water, it may be operated only through the incorporated prefilter. For this purpose remove the suction nozzle and cover the suction aperture with the attached cap.

There are two optional connection variations on the pressure side: the thread-adaptor for assembly of a pressure hose or an adaptor for the ascending pipe.

**B/C** The fixing plate can be transposed for universal pump assembly.

### Servicing and maintenance

**D/E** Remove power supply plug. Remove suction grille (squeeze sides lightly) and rinse coarse filter under running water.

If water is badly contaminated, clean filter more frequently. If pump is badly contaminated on suction or pressure side, this will simply lead to noise – time for a thorough cleaning.

Release pump cover (**D**) and remove pump parts as per drawing (**A**).

Clean pump vigorously with set of EHEIM cleaning brushes (order no. 4009570) as shown in fig. **E**: Clean pump parts under running water and reassemble in same sequence.

### Fountain pumps 3148010 - 3148200

Model: see type plate on pump housing

### Function

**F** ① Pump complete with coarse filter ② cap ③ adaptor piece ④ rising pipe ⑤ nozzle head.

The water intake of the pump occurs through the incorporated prefilter. Slip regulating clip over hole of pipe.

Place the riser pipe into the adaptor and attach the nozzle head.

### Accessory

⑥ It is possible to connect a bypass valve (order no. 3052400) between the adaptor and nozzle head, which allows the regulation of fountain height.

It is possible to connect a hose (order no. 4003940 or 4004940) for waterfall or ornament etc.

**G** Cleaning the nozzle head: see drawing.

### Universal centrifugal pumps 1048219 - 1048499 – not suitable for outdoor use –

Model: see type plate on pump housing

Similar to 1048019, but with 1.7 m PVC-cable. Not suitable for outdoor use, neither in swimming pools nor garden ponds.

**Merci**

d'avoir acheté la nouvelle pompe EHEIM, la garantie d'une efficacité optimale en toute sécurité et d'une fiabilité parfaite.

**Consignes de sécurité**

Pour tous travaux de nettoyage et d'entretien, débrancher les appareils électriques immergés ou en contact avec l'eau.



La ligne de raccordement de l'appareil ne peut être remplacée. En cas de détérioration de la ligne, cesser d'utiliser l'appareil. Ne jamais porter la pompe par son câble; ne pas plier le câble.



L'utilisation de ces pompes dans des étangs de jardin et leurs zones de protection est autorisée uniquement lorsque l'installation correspond aux réglementations en vigueur. Pour effectuer une protection contre la tension dangereuse de contact, l'installation ne doit pas présenter un dispositif de protection contre les courants de court-circuit avec un courant résiduel de référence de plus de 30 mA. Demandez conseil à votre électricien.



Cet appareil n'est pas destiné à être utilisé par des personnes (enfants y compris) aux capacités physiques, sensorielles ou intellectuelles limitées ou dépourvues d'expérience ou de connaissance, à moins qu'elles ne se trouvent sous la surveillance d'une personne responsable de la sécurité ou obéissent à ses recommandations sur la manière d'utiliser l'appareil.

Veillez surveiller les enfants afin de pouvoir être certain qu'ils ne jouent pas avec l'appareil.



20 cm

Remarque: avec ces appareils, des champs magnétiques peuvent provoquer des troubles ou des détériorations électroniques et mécaniques. Ceci est également valable pour les stimulateurs cardiaques. Les distances nécessaires de sécurité doivent être relevées dans les manuels de ces appareils médicaux.



Attention: en cas de travaux de maintenance, risque de coincement en raison de forces magnétiques élevées.



Ne pas jeter le produit à la poubelle. Ramenez-le à votre lieu de décharge locale.

Le produit est autorisé à l'emploi conformément aux réglementations et directives nationales respectivement en vigueur. Il respecte les normes adoptées par l'Union européenne.

**Pompe universelle 1048019 - 1048209**

– Adaptées à l'extérieur –

Version: voir indication de type sur le corps de la pompe

**Fonction**

- A** ① Corps du moteur ② Plaque de fixation ③ Embout fileté, côté pression ④ Ensemble turbine ⑤ Couvercle de pompe ⑥ Préfiltre ⑦ Grille d'aspiration ⑧ Embout fileté, côté aspiration ⑨ Couvercle de fermeture.

La pompe peut être installée hors de l'eau ou dans l'eau. Elle n'est pas auto-aspirante et lors du fonctionnement extérieur il faut la placer sous le niveau de l'eau.

**Mise en service**

Pour la mise en route aspirer brièvement à l'extrémité du tuyau de pression jusqu'à ce que l'eau coule vers la pompe. Brancher seulement maintenant le courant électrique. Un bref bruit de démarrage de la pompe est normal. Pour l'installation à l'extérieur.

Pour l'emploi de la Hobbypompe il existe différentes possibilités d'installations: pour le fonctionnement hors de l'eau on procède de préférence à l'aide de l'embout d'aspiration et du tuyau. Si la pompe doit fonctionner à l'état immergé, le passage par le préfiltre intégré est obligatoire. On dévisse dans ce cas l'embout d'aspiration et on obstrue l'ouverture à l'aide du couvercle joint à l'appareil.

Du côté pression on dispose au choix de deux possibilités de raccordement: des embouts filetés pour le montage d'un tuyau de pression ou d'un adaptateur pour le raccordement d'un tube gicleur.

**B/C** La plaque de fixation peut être déplacée pour un montage universel de la pompe.

### Nettoyage et entretien

**D/E** Retirer la prise de courant électrique. Enlever la grille d'aspiration (presser légèrement sur les côtés) et rincer le filtre sous l'eau courante.

Dans le cas d'une eau très chargée rincer le filtre plus fréquemment. Si la pompe est très encrassée du côté aspiration ou pression cela amène un bruit fort qui signale qu'il est temps de procéder au nettoyage approfondi.

Débloquer le couvercle (**D**) et retirer les éléments de la pompe conformément du dessin (**A**). Bien nettoyer la pompe à l'aide du set de brosses EHEIM (Réf. 4009570), comme indiqué sur la figure **E**. Nettoyer les éléments de la pompe sous l'eau courante et ensuite les remonter dans l'ordre indiqué.

### Pompe de fontaine 3148010 - 3148200

Version: voir indication de type sur le corps de la pompe

### Fonction

**F** ① Pompe complète avec préfiltre ② Couvercle ③ Adaptateur ④ Tube élévateur ⑤ Gicleur.

La pompe aspire par principé à travers le préfiltre intégré. Glisser le clip de régulation par-dessus le trou du tube élévateur. Fixer le tube élévateur dans l'adaptateur et placer le gicleur.

### Accessoire

**6** Entre l'adaptateur et le gicleur on peut placer un bypass (Réf. 3052400) qui permet de régler la hauteur du jet d'eau. En outre, on peut employer un tuyau (Réf. 4003940 ou 4004940) qui permet d'alimenter par ex. des cascades, des fontaines etc.

**G** Nettoyage du gicleur: voir dessin.

### Pompe rotative-universelle 1048219 - 1048499 – Non adaptées pour l'extérieur –

Version: voir indication de type sur le corps de la pompe

Construction identique à 1048019. Son câble PVC de 1,7 de long ne permet pas l'emploi pour bassins de plein air.

**Hartelijk dank**

Voor het kopen van Uw nieuwe EHEIM-pomp, die optimale capaciteit combineert met veiligheid en betrouwbaarheid.

**Veiligheidsvoorschriften**

Bij onderhoudswerkzaamheden alle stekkers van de zich in het water bevindende apparaten uit het stopcontact halen.



De aansluitkabel van dit apparaat kan niet vervangen worden. Bij beschadiging van de kabel mag het apparaat niet meer gebruikt worden. Pomp nooit aan de kabel dragen; kabel niet knikken.



Het gebruik bij tuinvijvers of in de buurt daarvan is alleen toegestaan als de installatie aan de voorschriften voldoet.

Ter bescherming tegen te hoge aanrakingsspanning mag de pomp alleen aangesloten worden op een geaarde contactdoos, die is aangesloten achter een aardlekschakelaar met een nominale aanspreekstroom van ten hoogste 30 mA. Raadpleeg Uw elektroninstallateur.



Dit toestel is niet voorzien voor gebruik door personen (kinderen inbegrepen) met beperkt fysiek, sensorisch of geestelijk vermogen of met gebrekkige ervaring of kennis behalve indien een voor de veiligheid bevoegde persoon op hen toezicht houdt of hen instructies heeft gegeven met betrekking tot de bediening van het toestel.

Op kinderen moet toezicht worden gehouden om te garanderen dat ze niet met het toestel spelen.



20 cm  **Waarschuwing:** Bij deze apparaten kunnen magnetische velden elektronische en mechanische storingen of beschadigingen veroorzaken. Dit geldt ook voor pacemakers. De vereiste veiligheidsafstand zijn in de handboeken van deze medische apparaten te vinden.



**Let op:** Door de grote kracht van de magneten kunnen bij het onderhoud kneuzingen veroorzaakt worden.



Dit product niet in het normale huisvuil gooien. Breng het naar uw lokaal afvalverwerkingspunt.

Dit product is volgens de verschillende nationale voorschriften en richtlijnen erkend en komt overeen met de EU-normen.

**Universeel-pomp 1048019 - 1048209**

**– voor buitengebruik geschikt –**

uitvoering: zie typeplaatje op het pomphuis

**Functie**

**A** ① Motordeel ② bevestigingsplaat ③ slangpilaar, drukzijde ④ pomp-rad-set ⑤ pompdeksel ⑥ groffilter ⑦ aanzuigzeef ⑧ slangpilaar, zuigzijde ⑨ afsluitdeksel.

De pomp kan zowel in als buiten het water gebruikt worden. Zij is niet zelf-aanzuigend en men moet haar derhalve bij toepassing buiten het water onder het niveau van de waterspiegel plaatsen.

**Ingebruikname**

Bij ingebruikname aan drukslangeinde kort aanzuigen tot water in de pomp komt. Eerst dan stekker in stopcontact. Een kort aanloopgeruis is normaal.

Voor buitengebruik is de pomp volgens de voorschriften met een 10 m kabel uitgerust.

Men kan de hobbypomp op verschillende manieren gebruiken: Bij gebruik buiten het water wordt bij voorkeur via de aanzuigpilaar met een slang gewerkt. Wordt de pomp in het water gebruikt dan mag ze slechts met de geïntegreerde voorfilter uitgerust zijn. In dat geval de zuigpilaar verwijderen en de aanzuigopening van de afsluitdeksel voorzien.

Aan de drukzijde staan naar keuze 2 aansluit-varianten ter beschikking: De slangpilaar voor montage van een drukslang of een adapter voor de stijgbuis.

**B/C** De bevestigingsplaat kan men t.b.v. een universele pompmontage verzetten. Pomp nooit aan de kabel optillen, kabel niet knikken.

### Reiniging en onderhoud

**D/E** Stekker uit stopcontact. Aanzuigzeef afnemen (aan de kant licht indrukken) en groffilter onder stromend water uitspoelen.

Bij sterk vervuild water groffilter vaker reinigen. Indien zuig- of drukzijde pomp sterk vervuild is leidt dat tot flink geruis: Tijd voor grondig schoonmaken.

Pompedeksel ontgrendelen (**D**) en pompdelen overeenkomstig tekening (**A**) uitnemen.

Pomp, zoals afgebeeld onder **E**, met EHEIM-borstelset (bestelnr. 4009570) goed schoonmaken; pompdelen onder stromend water reinigen en daarna in dezelfde volgorde terugplaatsen.

### Fonteinpomp 3148010 - 3148200

uitvoering: zie typeplaatje op het pomphuis

### Functie

**F** ① Pomp compleet met groffilter ② afsluitdeksel ③ adapter ④ stijgbuis ⑤ sproeierkop.

De pomp zuigt normaliter via de geïntegreerde voorfilter aan. Het reguleer-ventiel wordt over het gat van de stijgbuis geschoven.

Stijgbuis in adapter steken en sproeierkop opzetten.

### Toebehoren

**6** Tussen adapter en stijgbuis kan een bypass-ventiel (bestelnr. 3052400) geplaatst worden, die regulering van de spuithoogte mogelijk maakt.

Bovendien kan een bypass-slangleiding (bestelnr. 4003940 of 4004940) voor het in werking stellen van een verdere spuitfiguur aangebracht worden.

**G** Reiniging van de sproeierkop: Zie tekening.

### Universele centrifugaal-pomp 1048219 - 1048499

– niet voor buitengebruik geschikt –

uitvoering: zie typeplaatje op het pomphuis

Constructie als 1048019, evenwel met 1,7 m PVC-kabel. Niet voor buitengebruik, niet voor zwembaden en tuinvijvers.

**Tack**

för att du har bestämt dig för en EHEIM pump som kan garantera optimal prestanda i kombination med bästa säkerhet och tillförlitlighet.

**Säkerhetsanvisningar**

Skilj strömförsörjningen från nätet till elutrustningen som ligger i vattnet innan du utför underhåll eller skötsel.



Nätkabeln till denna pump kan inte bytas ut. Om kabeln har skadats får du inte längre använda pumpen. Bär aldrig pumpen i kabeln. Vik inte kabeln.



Pumpen får endast användas i trädgårdsdammar samt inom det angränsande skyddsområdet om installationen uppfyller kraven i gällande föreskrifter.

För att användaren ska skyddas mot alltför höga beröringsspänningar måste pumpen ha anslutits till ett uttag som är kopplat till en jordfelsbrytare med en nominell läckström på max. 30 mA. Kontakta en behörig elektriker.



Denna apparat är inte avsedd att användas av personer (inklusive barn) med begränsad fysisk, sensorisk eller mental förmåga eller som saknar erfarenhet och/eller kunskaper, om inte vederbörande står under uppsikt av en person som ansvarar för säkerheten eller erhåller anvisningar från denna person om hur apparaten ska användas.

Barn ska övervakas för att säkerställa att de inte leker med apparaten.



Obs! Vid dessa pumpar kan magnetfält framkalla elektroniska eller mekaniska störningar eller skador.

Detta gäller även för pacemakers. Erforderliga säkerhetsavstånd anges i handböckerna till de medicinska utrustningarna.



Varning! Risk för klämskador vid underhåll pga. höga magnetiska krafter.



Denna produkt ska inte kastas bort i de normala hushållssoporna. Lämna in den till det lokala återvinningsstället.

Produkten har godkänts enligt gällande nationella föreskrifter och direktiv och uppfyller tillämpbara EU-direktiv.

**Universalpumpar 1048019 - 1048209**

– Lämplig för utomhusbruk –

Version: se typskylten på pumphuset

**Funktion**

- A** ① Motordel ② Fästplatta ③ Anslutningsstuds – utlopp ④ Pump-hjuls-set ⑤ Pumphuslock ⑥ Grovfilter ⑦ Gallerkåpa – insug ⑧ Anslutningsstuds – inlopp ⑨ Täckplatta – insug.

Pumpen kan användas såväl under som ovan vatten. Den är inte självsugande och måste därför vid drift ovan vatten placeras under vattenytans nivå.

**Driftstart**

För igångsättning suger man lite vid tryckslangens slut tills vatten rinner in i pumpen. Sätt först nu i kontakten. Ett kort igångsättningsljud är normalt.

Användningsområdena för Hobbypumpen är många. Vid användning ovan vatten är det lämpligt att ha en slang över anslutningsnippeln. Används pumpen under vatten, får den bara drivas över det integrerade förfiltret. Anslutningsnippeln skruvas då av och insugsöppningen försluts med tillslutningslocket.

På trycksidan har man två anslutningsalternativ att välja på; anslutningsnippeln för att koppla på en tryckslang eller en mellandel för stigarröret.

**B/C** Fästplattan lämpar sig för alla pumppontage.

### Underhåll och rengöring

**D/E** Dra ut kontakten. Ta av insugsgallret (tryck ihop det och vrid lätt) och skölj grovfiltret under rinnande vatten.

Vid stark vattenförorening bör grovfiltret rengöras oftare. Om pumpen vid sug- eller trycksidan är starkt igensatt, leder detta till en högre ljudnivå vid drift. Då är det tid för grundlig rengöring.

Frigör pumplocket (**D**) och ta ut pumpdelarna enligt skiss (**A**).

Rengör pumpen såsom bild **E** visar med EHEIMs set av rengöringsborstar (nr. 4009570). Rengör pumpdelarna under rinnande vatten och sätt efter hand ihop dem igen.

### Springbrunnspumpar 3148010 - 3148200

Version: se typskylten på pumphuset

### Funktion

**F** ① Pump komplett med grovfilter ② Tillslutningslock ③ Mellandel  
④ Stigarrör ⑤ Strilhuvud.

Pumpen suger huvudsakligen in över det integrerade förfiltret. Reglerclipset skjuts över stigarrörets hål.

Montera stigarröret i adaptern och fäst strilhuvudet på toppen.

### Tillbehör

**B** Man kan också montera ett sidouttag (nr. 3052400) mellan adaptern och strilhuvudet och på så sätt reglera fontänhöjden.

Detta möjliggör också att ansluta en slang (nr. 4003940 och 4004940) och på så sätt koppla in ett vattenfall eller någon dekorationsfigur.

**G** Rengöring av strilhuvudet: se skiss.

### Universal Cirkulationspump 1048219 - 1048499

– Ej lämplig för utomhusbruk –

Version: se typskylten på pumphuset

Samma konstruktion som 1048019. Med 1,7 m PVC-kabel. Ej lämplig för utomhusbruk.

**Mange takk**

for innkjøpet av din nye EHEIM pumpe, som tilbyr optimal effekt og samtidig høyeste sikkerhet og pålitelighet.

**Sikkerhetsinstruksjoner**

Ved vedlikeholdsarbeider og pleie må alle de elektroapparatene som befinner seg i vannet skilles fra nettet.



Forbindelsesledningen til dette apparatet kan ikke erstattes. Dersom ledningen blir skadet, må apparatet ikke brukes lengre. Bruk aldri kabelen til å bære pumpen med; kabelen skal heller ikke bøyes.



Bruk av pumpen i hagedammer og i området rundt disse er kun tillatt under forutsetning av at installasjonen er i samsvar med gjeldende forskrifter.

Til beskyttelse mot for høy berøringsspenning må installasjonen være utstyrt med en verneinnretning mot feilstrøm med en målt reststrøm på ikke mer enn 30 mA. Vennligst spør din elektrofagmann.



Dette apparatet er ikke egnet for bruk av personer (inklusive barn) med nedsatte fysiske, sensoriske eller mentale evner eller med manglende erfaring og/eller manglende kunnskaper, med mindre disse personene er under oppsikt av en annen person som er ansvarlig for deres sikkerhet eller har fått anvisninger fra en slik person om hvordan apparatet skal brukes.

Barn skal holdes under oppsikt for å unngå at de leker med apparatet.



20 cm  Merk: Ved disse apparatene kan magnetfelt forårsake elektroniske og mekaniske forstyrrelser eller skader. Dette gjelder også for pacemakers.

De nødvendige sikkerhetsavstandene står oppført i håndbøkene som tilhører disse medisinske apparatene.



**OBS!** Ved vedlikeholdsarbeider er det fare for å skade seg pga. sterke magnetkrefter.



Produktet må ikke kastes som vanlig husholdningsavfall. Det skal leveres til ditt lokale deponi.

Produktet er prøvet ifølge de respektive nasjonale forskrifter og er i samsvar med EU-normene.













































































































































































































































































































For utendørsbruk er pumpen forskriftsmessig utstyrt med en 10 m kabel.

Det finnes flere bruksområder for denne Universal-hobbypumpe: Når pumpen brukes utenfor vann, kobles en slange til tilslutningsrøret på sugesiden. Ved bruk nedsenket i vann brukes det integrerte forfilter. Tilslutningsrøret på sugesiden skrues da ut, og åpningen lukkes med det medfølgende deksel.

På trykksiden finnes to tilslutningsalternativer. Det ene er et tilslutningsrør for slange. I tillegg finnes en adapter til stigerøret.

**B/C** Festeplaten kan flyttes og tilpasses flere montasjebehov. Pumpen må aldri løftes etter kabelen, og kabelen må ikke bøyes.

### Stell og vedlikehold

**D/E** Ta ut kontakten. Løsne og ta av forfiltergitteret (trykk forsiktig på sidene) og skyll grovfilteret grundig i kaldt vann.

Hvis vannet der pumpen er i bruk er meget skittent, bør grovfilteret rengjøres ofte. Hvis rørene på trykk eller sugeside er tilsmusset, fører dette gjernetil støy. En grund rengjøring er da nødvendig.

Åpne pumpehuset ved å vri holder-ringen. **(D)** Ta ut pumpedelene som bilde **(A)** viser.

Rens pumpedelene i rennende vann, og alle rørstykker men en egnet rensebørste **(E)** (Best. nr. 4009570). Sett deretter pumpen sammen igjen nøyaktig som tegningen viser.

### Fontenepumpene 3148010 - 3148200

Utførelse: Se typeskiltet på pumpehuset

### Funksjon

**F** ① Pumpe komplett med grovfilter ② Lukkedeksel ③ Adapterstykke ④ Stigerør ⑤ Dysehode.

Pumpen suger vann gjennom det integrerte forfilteret. Reguleringsklipsen trykkes over hullet i stigerøret.

Monter stigerøret på medfølgende rørbobling som igjen kobles på pumpens dysehode.

### Tilbehør

**6** Avlastingsventil (best.-nr. 3052400) kan monteres mellom rørboblingsstykket og dysehodet for regulering av vannstrålehøyden. Slange (best.-nr. 4003940 eller 4004940) kan benyttes ved bygging av vannfall etc.

**G** Rensing av dysehodet, se tegning.

### Universal-sirkulasjonspumpe 1048219 - 1048499 – ikke egnet for utendørs bruk –

Utførelse: Se typeskiltet på pumpehuset

Likedan oppbygd som 1048019, med kabel på 1,7 m. Egner seg ikke for utendørs bruk.

## Paljon kiitoksia

siitä että ostitte uuden EHEIM pumpun, joka tarjoaa teille parhaan mahdollisen työsuorituksen ja joka on erittäin turvallinen ja luotettava.

### Turvallisuusmääräykset



Huolto- ja hoitotoimien aikana on kaikki vedessä olevat sähkölaitteet irroitettava sähköverkosta.



Tämän laitteen verkkoliitäntäjohtoa ei voi vaihtaa uuteen. Jos johto vahingoittuu, ei laitetta saa enää käyttää. Älä koskaan kannaa moottoria johdosta; älä-taita johtoa.



Pumpun käyttö puutarhaaltaissa ja niiden suojaalueella on sallittua vain, jos asennus on suoritettu voimassa olevien säädöksien mukaisesti.

Suojana liian korkeaa kosketusjännitettä vastaan asennuksessa on oltava virhevirta-suojalaitte, jossa on korkeintaan 30 mA:n mittausjännönsvirta. Kysykää sykkää sähköasiantuntijaltanne.



Tätä laitetta ei ole tarkoitettu sellaisten henkilöiden (mukaanlukien lapset) käyttöön, joiden fyysiset, sensoriset tai henkiset kyvyt ovat puutteelliset joltuen kokemuksen ja/tai tiedon puutteesta, ellei turvallisuudesta vastuussa oleva henkilö valvo käyttöä tai ole antanut ohjeita miten laitetta käytetään asianmukaisesti.

Valvo lasten käyttäytymistä ja varmista, että he eivät leiki laitteella.



20 cm Viite: Magneettikentät voivat aiheuttaa näissä laitteissa elektroni-  
sia tai mekaanisia häiriöitä tai vaurioita. Tämä koskee myös sydämen tahdistinta.

Tarpeelliset turvallisuusetäisyydet voidaan löytää näiden lääke tieteellisten laitteiden käsikirjoista.



Huomio: huoltotöissä ruhjontavaara suurten magneettivoimien johdosta.



Tätä pumpppua ei saa hävittää tavallisten kotitalousjätteiden joukossa. Toimita käytöstä poistettu laite asianmukaiseen jätteenkeruupisteeseen.

Tuote on hyväksytty kunkin maan kansallisten määräysten ja ohjesääntöjen mukaan ja se vastaa EU-standardien määräyksiä.



### Yleispumput 1048019 - 1048209 – sopivia avomaakäyttöön –

Valmistustapa: katso nimilaattaa pumpun suojuksessa

### Toiminta

- A** ① Moottorirunko ② Kiinnityslevy ③ Kierreistukka, paineenpuoleinen  
④ Pumpppyöräsarja ⑤ Pumpun kansi O-renkaineen ⑥ Karkeasuodatin  
⑦ Imuristikko ⑧ Kierreistukka, imupuoleinen ⑨ Sulkukansi.

Pumpppua voidaan käyttää sekä veden alla että ilmatilassa. Pumpppu ei ole itseimevä, joten se täytyy ilmatilassa käytettäessä asentaa veden pintatason alapuolelle.

### Käyttöönotto

Pumpppua käyttöön otettaessa imetään poistoletkun päästä vettä siten että se virtaa pumppuun. Vasta tämän jälkeen kytketään pumpppu verkkovirtaan. On normaalia, että pumpppu tällöin lyhtäikaisesti pitää kovempaa ääntä.

Hobby-pumppua voidaan käyttää monella eri tavalla: veden ulkopuolella pumppua käytettäessä yhdistetään letku pumpuun suuttimella. Kun pumppua käytetään vedessä, on aina käytettävä pumpuun päähän asennettavaa esisuodatinta. Tätä tarkoitusta varten poistetaan suutin ja aukko peitetään suljiinosalla.

Poistopuolen ulostuloaukko voidaan yhdistää kahdenlaisilla yhdyskappaleilla: letkuun liitettävällä kierreliittimellä tai eri suuttimiin sovitettavalla kierreliittimellä tai eri suuttimiin sovitettavalla kierreliittimellä.

**B/C** Kiinnityslista voidaan asentaa pumpuun eri puolille.

### Hoito ja huolto

**D/E** Vetäkää johto sähköverkosta. Irroittakaa imusiivilä puristaen kevyesti sivuista ja puhdistakaa esisuodatin juoksevan veden alla.

Jos vesi on kovin likaista on esisuodatin puhdistettava usein. Jos pumppu on imu- tai poistopuolella hyvin likainen, ääni voimistuu, ja silloin on aika suorittaa perusteellinen puhdistus.

Kiertäkää lukkorengas irti (**D**) ja irroittakaa pumpun osat (**A**).

Pumppu harjataan puhtaaksi harjoilla (til.nro 4009570) kuten kuvassa **E**. Osat puhdistetaan juoksevan veden alla ja asetetaan jälleen paikoilleen kuvan osoittamassa järjestyksessä.

### Suihkulähdepumppu 3148010 - 3148200

Valmistustapa: katso nimilaattaa pumpun suojuksessa

### Toiminta

**F** ① Täydellinen pumppu esisuodattimen kanssa ② Suljiinosa ③ Sovitettava kierreliitin ④ Nousuputki ⑤ Suihkusuutin.

Pumppu imee pääsasiallisesti esisuodattimen kautta. Suihkukorkeuden säädin työnnetään nousuputkessa olevan aukon päälle.

Laittakaa nousuputki kierreliittimeen ja kiinnitäkää suihkusuutin.

### Lisätarvikkeet

⑥ Ohitusventtiili (til.nro 3052400) voidaan asentaa kierreliittimen ja nousuputken väliin, joka mahdollistaa suihkukorkeuden säädön.

Pumppuun on myös mahdollista asentaa letku (til.nro 4003940 tai 4004940) veden ohivirtausta varten.

### Universal keskipakopumppu 1048219 - 1048499 – ei sovi avomaakäyttöön –

Valmistustapa: katso nimilaattaa pumpun suojuksessa

Samanlainen kuin 1048019, varustettu 1,7 m kaapelilla (PVC), oi sovellu ulkoilmakäyttöön.

**Tak,**

fordi du har valgt at købe en EHEIM-pumpe, der vil arbejde optimalt med den største sikkerhed og pålidelighed.

**Sikkerhedsanvisninger**



Ved eftersyn og vedligeholdelsesarbejde skal alle elektriske apparater, der befinder sig under vand, afbrydes fra nettet.



Tilslutningsledningen på dette apparat kan ikke udskiftes. Hvis ledningen bliver beskadiget, må apparatet ikke anvendes længere. Bær aldrig pumpen i ledningen, og undgå at lave knæk på ledningen.



Anvendelse i havebassiner og i deres umiddelbare nærhed er kun tilladt, hvis installationen opfylder de gældende forskrifter.

Som beskyttelse mod for høj berøringsspænding skal installationen være forsynet med en fejlstrømsanordning med en målt reststrømstyrke på ikke over 30 mA. Spørg en elektriker til råds.



Apparatet er ikke beregnet til at blive anvendt af personer (herunder også børn) med indskrænkede fysiske, sensoriske eller åndelige evner eller som ikke råder over den tilsvarende erfaring og/eller viden, hvis ikke der føres tilsyn af en person, som er ansvarlig for sikkerheden og som giver de tilsvarende instruktioner om, hvordan apparatet skal benyttes.

Der skal føres tilsyn med børn for at sikre, at de ikke leger med apparatet.



20 cm



**Bemærk!** Disse pumper frembringer magnetfilter, der kan forårsage elektroniske og mekaniske fejl eller skader. Dette gælder også for pacemakere.

De nødvendige sikkerhedsafstande fremgår af dokumentationen til disse medicinske apparater.



**Advarsel:** Ved vedligeholdelsesarbejde er der fare for klemning på grund af de magnetiske kræfter.



Dette produkt må ikke bortskaffes sammen med det normale husholdningsaffald. Aflever produktet hos det lokale genbrugscenter.

Produktet er godkendt efter gældende nationale forskrifter og direktiver og opfylder EU-normene.



**Universalpumper 1048019 - 1048209**

**– Eget til udendørs brug –**

Udførelse: Se typeskiltet på pumpehuset

**Funktion**

- A** ① Motorhus ② Monteringsplade ③ Gevindstuds – trykside ④ Pumpehjul-sæt ⑤ Pumpelåg ⑥ Grovfilter ⑦ Indsugningsgitter ⑧ Gevindstuds – sugeside ⑨ Lukkedæksel.

Pumpen kan anvendes både under vand og på friland. Den er ikke selvansugende og skal derfor placeres under vandspejlets niveau, når den skal fungere på friland.

**Ibrugtagning**

For at få pumpen i gang suges der i slangen i tryksiden, til vandet løber ind i pumpen. Først nu slutes strømmen til.

Det er normalt, at pumpen støjer en smule ved opstart.

For installation på friland er pumpen forskriftsmæssigt forsynet med 10 m kabel.

Der er forskellige indsatsmuligheder for driften af hobbypumpen. Ved drift på friland bør der sættes en slange på sugestudsens. Hvis pumpen bruges under vand, må den kun anvendes med det integrerede forfilter. Sugestudsens skal derved drejes ud; og indsugningsåbningen dækkes til med vedlagte låg.

På tryksiden har man to forskellige tilslutningsmuligheder til rådighed: gevindstudsens monteres til trykslangen, eller adaptoren monteres til stigrøret.

**B/C** Fastspændingspladen kan monteres eller flyttes til den ønskede position.

### Pleje og vedligeholdelse

**D/E** Træk stikket ud. Indsugningssien fjernes (trykkes let sammen fra siderne) og grovfilter skylles under rindende vand.

Ved stærkt tilsmudset vand bør grovfiltret rengøres oftere. Er pumpen tilsmudset i både suge- og trykside vil dette medføre støjdannelse: Så er det tid for en grundig rengøring af pumpen.

Rotordækslet (**D**) skrues af, og pumpedelene tages ud som vist på tegning (**A**).

Pumpen gøres ren med EHEIM-rengøringsset (best. nr. 4009570) som vist på billede **E**. Pumpedelene rengøres under rindende vand og sættes til sidst sammen igen i samme rækkefølge.

## Springvandspumpe 3148010 - 3148200

Udførelse: Se typeskiltet på pumpehuset

### Funktion

**F** ① Komplet pumpemodul med grovfilter ② Låg ③ Adapter ④ Stigrør ⑤ Dysehoved.

Pumpen suger hovedsageligt ind over det integrerede forfilter. Reguleringsklipsen skubbes hen over stigrørets hul.

Anbring stigrøret i rørformstykket og forbind dysehovedet.

### Tilbehør

**6** Aflastningsventil (best. nr. 3052400) kan indbygges mellem rørformstykke og dysehoved til regulering af højden på springvandet. Slange (best. nr. 4003940 eller 4004940) kan tilsluttes til vandfald, udsmykning, etc.

**G** Rengøring af dysehoved: Se tegning.

## Universal-cirkulationspumpe 1048219 - 1048499

– Ikke egnet til udendørs brug –

Udførelse: Se typeskiltet på pumpehuset

Opbygning som 1048019 dog med 1,7 m PVC-kabel. Ikke egnet til frilandsbrug (havebassiner og svømmebassiner).

**Grazie**

per aver acquistato la vostra nuova pompa EHEIM che offre prestazioni ottimali ai massimi livelli di sicurezza e affidabilità.

**Avvertenze di sicurezza**

Durante gli interventi di cura e manutenzione, si devono disinserire dalla rete tutti gli apparecchi elettrici immersi in acqua.



Non si deve sostituire la linea di allacciamento di questo apparecchio. In caso di danneggiamento della linea, l'apparecchio non potrà più essere utilizzato. Non portare mai la pompa tenendola per il cavo, non piegare il cavo.



E' ammesso l'uso in vasche da giardino e nella loro area di protezione solo se l'installazione è realizzata in modo conforme alle norme vigenti. Per la protezione contro la tensione di contatto troppo elevata, l'installazione deve presentare un dispositivo di protezione per correnti di guasto con una corrente residua di taratura non superiore a 30 mA. A tale proposito si prega di consultare il proprio elettricista.



Il presente apparecchio non è progettato per essere utilizzato da persone (bambini compresi) con ridotte capacità fisiche, sensoriali o psichiche o che non siano dotate della necessaria esperienza/conoscenza, a meno che non siano assistite e controllate da una persona addetta alla sicurezza o ricevano dalla stessa le istruzioni relative all'utilizzo dell'apparecchio. Tenere sempre sotto controllo i bambini, per assicurarsi che non giochino con l'apparecchio.

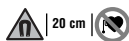

20 cm | Avvertenza: in questi apparecchi, i campi magnetici possono causare malfunzionamenti o avarie elettroniche e meccaniche. Questo vale anche per i pacemaker. Le distanze di sicurezza da rispettare sono indicate nei manuali d'uso di tali apparecchiature medicali.



Attenzione: durante gli interventi di manutenzione sussiste il rischio di schiacciamento originato da forze magnetiche elevate.



Non smaltire il prodotto assieme ai comuni rifiuti domestici. Consegnare il prodotto alla discarica locale autorizzata.

Il prodotto è omologato secondo le vigenti disposizioni e direttive nazionali ed è conforme alle norme EU.

**Pompa universale 1048019 - 1048209**

– indicate per l'uso all'aperto –

Versione: vedere targhetta di identificazione sul corpo della pompa

**Funzionamento**

- A** ① Blocco motore ② base ③ bocchettone filettato di mandata ④ gruppo girante ⑤ coperchio con guarnizione ad anello ⑥ prefiltro ⑦ griglia di aspirazione ⑧ bocchettone filettato di aspirazione ⑨ coperchio di chiusura.

La pompa può essere impiegata sia immersa nell'acqua che fuori. Non è auto-adescente e conseguentemente, se è fatta funzionare fuori dall'acqua, deve essere collocata al di sotto del livello della stessa.

**Messa in esercizio**

Per l'avviamento, aspirare brevemente all'estremità del tubo di mandata fino a quando l'acqua fluisce alla pompa. Solo ora collegare la spina alla rete elet-

trica. Un rumore di avviamento di pochi secondi è normale. Per l'uso all'aperto la pompa è corredata di un cavo regolamentare lungo 10 m.

Per il funzionamento della pompa Universal-Hobby esistono varie modalità d'uso: se è impiegata fuori dall'acqua, sarà preferibile farla lavorare mediante il raccordo di aspirazione con un tubo flessibile. Se la pompa è immersa nell'acqua, la si può far funzionare solo munita del prefiltro integrato. A tale scopo si svita il raccordo di aspirazione e si chiude il foro con il tappo in dotazione.

Per la mandata sono disponibili, a scelta, due varianti di collegamento: il raccordo filettato per il montaggio di un tubo di mandata oppure un adattatore per il tubo spruzzatore.

**B/C** La piastra di fissaggio è spostabile per consentire di montare la pompa in posizioni diverse.

### Cura e manutenzione

**D/E** Disinserire la spina dalla rete elettrica. Togliere la griglia di aspirazione (con una leggera pressione laterale) e sciacquare il prefiltro sotto acqua corrente.

In caso di acqua molto sporca, sciacquare piuttosto spesso il prefiltro. Quando la pompa sia molto sporca all'entrata o all'uscita dell'acqua, si udirà un forte rumore: segnale, questo, che la pompa necessita di un'accurata pulizia.

Sbloccare il coperchio della pompa (**D**) e togliere le parti della pompa come da disegno (**A**). Pulire accuratamente la pompa, come illustrato nel disegno **E**, con il set di scovoli EHEIM (nr. d'ord. 4009570). Sciacquare le parti della pompa sotto acqua corrente e, successivamente, reinserirli nella loro sede nello stesso ordine.

### Pompa per fontana 3148010 - 3148200

Versione: vedere targhetta di identificazione sul corpo della pompa

### Funzionamento

**F** ① Pompa completa con prefiltro ② coperchio di chiusura ③ adattatore ④ tubo ⑤ ugello.

Di principio la pompa aspira l'acqua attraverso il prefiltro integrato. La clip di regolazione va posizionata sopra il foro del tubo. Unire l'ugello per lo zampillo con il bocchaglio ed inserire il tutto nell'apposito adattatore.

### Accessori

**G** È possibile inserire una valvola bypass tra l'adattatore ed il bocchaglio (nr. d'ord. 3052400), che permette la regolazione dell'altezza dello zampillo. È anche possibile collegare un tubo flessibile (nr. d'ord. 4003940 o 4004940) per la creazione di cascatelle ed altri giochi d'acqua.

**G** Limpezia de la cabeza de tobera come illustrato nel disegno.

### Pompa universale 1048219 - 1048499 – non indicate per l'uso all'aperto –

Versione: vedere targhetta di identificazione sul corpo della pompa

Pompa di costruzione uguale alla 1048019, tuttavia munita di cavo (PVC) lungo 1,7 m; non è indicata per l'uso all'aperto.

**Le damos las gracias**

por la compra de su nueva bomba EHEIM, que le ofrecerá un rendimiento óptimo a la vez que máxima seguridad y fiabilidad.

**Advertencias de seguridad**

Antes de proceder a efectuar trabajos de limpieza y de mantenimiento, deben desconectarse de la red todos los aparatos eléctricos, que estén dentro del agua.



El cable de alimentación de este aparato no puede cambiarse. En caso de que dicho cable resulte dañado, ya no se debe utilizar el aparato. No transporte nunca la bomba cogida por el cable; no doble el cable.



El empleo en estanques de jardín y en la zona de protección de éstos sólo se permite, si la instalación se corresponde con las normas vigentes. Como protección contra una tensión de peligro de electrocución, la instalación debe tener un dispositivo de protección contra corriente de defecto con una corriente residual de referencia no superior a 30 mA. Rogamos, consulte a su experto electricista.



Este aparato no está pensado para las personas (incluidos los niños) que tengan mermadas sus capacidades físicas, sensoriales o mentales ni debe ser utilizado por personas que carezcan de la experiencia y/o los conocimientos necesarios, a no ser que estas personas sean supervisadas por un responsable de seguridad o recibieron las instrucciones necesarias para utilizar el aparato. Vigile a los niños para evitar que jueguen con este aparato.



Nota: En estos aparatos, los campos magnéticos pueden causar fallos o daños electrónicos y mecánicos. Lo antedicho también rige para marcapasos. Las distancias necesarias de seguridad deben consultarse en los manuales de dichos aparatos médicos.



Atención: Peligro de aplastamiento en trabajos de mantenimiento por altas fuerzas magnéticas.



No tire este producto a la basura doméstica normal. Llévelo a su punto local de eliminación de residuos.

El producto está aprobado según las precripciones y directrices nacionales de cada país y cumple las normas de la UE.

**Bomba universal 1048019 - 1048209**

– aptas para campo libre –

Acabado: véase placa de características en la carcasa de la bomba

**Función**

- A** ① Cuerpo del motor ② Placa de fijación ③ Sección de tubo roscado, lado de la presión ④ Juego de rodete de bomba ⑤ Tapa de bomba ⑥ Filtro ordinario ⑦ Filtro de aspiración ⑧ Sección de tubo roscado, lado de la aspiración ⑨ Tapa de cierre.

La bomba puede emplearse tanto dentro como fuera del agua. No es auto-aspirante y por lo tanto, al trabajar fuera del agua, la bomba deberá situarse debajo del nivel del agua.

**Puesta en servicio**

Para la puesta en marcha aspirar brevemente en el extremo del tubo de aspi-



ración, hasta que llegue el agua a la bomba. Ahora es cuando se puede enchufar a la red. Un breve ruido de arranque de la bomba es normal. Para la instalación a la intemperie la bomba esta dotada reglamentariamente de un cable de 10 m.

Para el servicio de la bomba Hobby existen diversas posibilidades de empleo: al utilizarla fuera del agua se trabaja preferentemente a través del tubo de aspiración con una manga. Si la bomba se utiliza dentro del agua, sólo puede hacerse funcionar a través del prefiltro integrado.

El tubo de aspiración se desenrosca para ello y se tapa el orificio de aspiración con la tapa de cierre adjunta.

Por el lado de presión hay disponibles a discreción dos variantes de empalme: el tubo roscado para montar una manga de presión ó un adaptador para el tubo ascendente.

**B/C** La placa de fijación puede desplazarse al lado deseado para el montaje universal de bombas.

### Cuidados y mantenimiento

**D/E** Tirar del enchufe de la red, quitar la rejilla de aspiración (presionar ligeramente por los lados) y lavar el filtro grueso bajo agua corriente.

Si el agua esta muy sucia, limpiar el citado filtro más a menudo. Si la bomba esta muy sucia por el lado de aspiración ó de presión ello conducirá a fuertes ruidos: señal para una limpieza a fondo.

Desbloquear el anillo de sujeción (**D**) y sacar las piezas de la bomba de acuerdo (**A**). Limpiar fuertemente las piezas de las bombas según muestra fig. **E** con el juego de cepillos EHEIM (n° de pedido 4009570); limpiar las piezas de la bomba al grifo y volver a montarlas a continuación en el mismo orden.

### Bomba para surtidor 3148010 - 3148200

Acabado: véase placa de características en la carcasa de la bomba

### Función

**F** ① Bomba completa con el prefiltro grueso ② Tapa de cierre ③ Tubo roscado de adaptador ④ Tubo ascendente ⑤ Cabeza de tobera.

La bomba aspira en principio a través del prefiltro integrado.

### Accesorio

**G** El clip regulador se empuja sobre el orificio del tubo ascendente (n° de pedido 3052400). Según hasta donde este cerrado el orificio varia la altura que alcanza el surtidor. Un conducto de manga de bypas (n° de pedido 4003940/4004940) en el pivote de empalme puede utilizarse para hacer funcionar otro surtidor más.

**G** Limpieza de la cabeza de tobera.

### Bomba centrifuga universal 1048219 - 1048499 – no aptas para campo libre –

Acabado: véase placa de características en la carcasa de la bomba

De construcción igual a la 1048019, pero con cable de 1,7 m. No se presta para exteriores, ni para piscinas ni estanques de jardín.

**Děkujeme Vám,**

že jste si zakoupili nový čerpadlo EHEIM. Tento produkt Vám poskytne optimální výkon při maximální spolehlivosti a nejvyšší účinnosti.

**Bezpečnostní pokyny**

Při údržbě a čištění je nutno všechny elektrické spotřebiče, které jsou ve vodě, odpojit od sítě.



Přípojnou šňůru tohoto spotřebiče nelze nahradit. Poškodil se přívod, nesmí se spotřebič používat. Nikdy nenoste čerpadlo za šňůru ani ji nelámějte.



Používání přístroje v umělých rybníčcích na zahrádce resp. v jejich ochranném prostoru je dovoleno pouze za předpokladu, že instalace bude vyhovovat platným předpisům. Za účelem prevence proti vysokému dotykovému napětí musí být instalace vybavena zařízením na ochranu proti svodovému proudu, jehož vyměřovací zbytkový proud nesmí přesahovat 30 mA. Obratě se, prosím na specializovaného elektrotechnika.



Tento přístroj není určen k tomu, aby jej používaly osoby (včetně dětí) s omezenými fyzickými, senzoryckými či duševními schopnostmi anebo s nedostatečnými ušesnostmi a/nebo nedostatečnými vědomostmi. To je možné pouze za přímého dohledu osoby zodpovědné za bezpečnost anebo po instrukci takovouto osobou, jak přístroj používat. Dávejte pozor na děti, aby si s přístrojem nehrály.



20 cm  V důsledku magnetického pole z těchto přístrojů může docházet k elektronickým nebo mechanickým poruchám či poškození jiných přístrojů. To platí i pro kardiostimulátory. Potřebné vzdálenosti zjistíte z příruček k takovým lékařským přístrojům.



Při údržbě buďte pozorní – vysoké magnetické síly Vám mohou způsobit pohmoždění prstů.



Tento produkt nevyhazujte do normálního domovního odpadu. Odevzdejte jej do místní sběrný resp. do místa pro likvidaci odpadu.

Výrobek je schválen podle platných národních předpisů a směrnic a odpovídá normám EU.

**Univerzální čerpadlo 1048019 - 1048209**

**– vhodné pro venkovní použití –**

Provedení: viz typový štítek na čerpadle

**Funkce**

- A** ① Motor ② upevňovací deska ③ závitový adaptér, výtlačná strana ④ hnací část ⑤ viko čerpadla s O-kroužkem ⑥ hrubý filtr ⑦ sací rošt ⑧ závitový adaptér, sací strana ⑨ čepička.

Čerpadlo lze užít ve vodě i mimo vodu. Není sámomasávací a musí tedy být umístěno níže než je hladina vody, pokud pracuje mimo akvárium.

**Uvedení do provozu**

Aby se stalo funkční, sjeďte konec výtlačné hadice, až voda nateče do čerpadla. Nezapínejte je do sítě, dokud jste do něj nenasáli vodu. Krátkodobý hluk při zapnutí čerpadla je normální.

Čerpadlo určené pro venkovní použití je vybaveno v souladu s předpisy gumovým kabelem o délce 10 m.

Pro užití tohoto hobby čerpadla je několik alternativ: užíváte-li je mimo vodu, je lépe použít sací hubici s hadicí. Je-li čerpadlo užíváno ve vodě, smí pracovat pouze s předfiltrem. V tomto případě odstraňte sací hubici a přikryjte sací část přiloženou čepičkou.

Na výtlačné straně lze volit z dvou možných variací spojení: pomocí závitového adaptéru pro připojení výtlačné hadice nebo pomocí adaptéru pro výstupní trubici.

**B / C** Při montáži univerzálního čerpadla lze použít upevňovací desku.

### Servis a údržba

**D / E** Nejprve vypněte zařízení ze sítě. Odstraňte sací rošt (lehce zmáčkněte ze stran) a hrubý filtr promyjte pod tekoucí vodou.

Je-li voda hodně znečištěná, čistěte filtr častěji. Je-li čerpadlo hodně znečištěno na sací nebo výtlačné straně, začne být hlučné – nastal čas pro vyčištění.

Odstraňte víko čerpadla (**D**) a součástky čerpadla vyndejte podle obrázku (**A**).

Čerpadlo důkladně vyčistěte pomocí kartáčů EHEIM (obj. č. 4009570) jak ukazuje obr. **E**: součástky čerpadla čistěte pod tekoucí vodou a smontujte ve stejném uspořádání.

### Čerpadlo pro fontánu 3148010 - 3148200

Provedení: viz typový štítek na čerpadle

### Funkce

**F** ① kompletní čerpadlo s hrubým filtrem ② víko ③ adaptér ④ stoupací trubice ⑤ růžice.

Čerpadlo nasává zásadně přes integrovaný hrubý filtr. Adaptér na výtlačné straně slouží jako přípojka na stoupací trubici. Stoupací trubice ze zasune do adaptéru a nasadí se růžice.

### Příslušenství

**6** Mezi adaptér a stoupací trubici je možno nainstalovat chrlič (obj. č. 3052400) s regulací výšky proudu stříkající vody.

Kromě toho je možno připojit ještě také obtokovou hadici (obj. č. 4003940 nebo 4004940) na další chrlič.

**G** Čištění růžice: viz obrázek.

### Univerzální odstředivé čerpadlo 1048219 - 1048499

– nevhodné pro venkovní použití –

Provedení: viz typový štítek na čerpadle

Stejně jako 1048019, ale s 1,7 m kabelem. Není vhodné pro použití venku.

**Благодарим Вас**

за покупку нового EHEIM, сочетающего в себе высокую производительность, безопасность и надежность в эксплуатации.



**Указания по технике безопасности**

 При работах по техобслуживанию и уходу, все электроприборы, находящиеся в воде, необходимо отсоединить от сети.

 Соединительный провод данного прибора запрещено заменять. В случае повреждений, прибором запрещено пользоваться. Ни в коем случае не держать насос за кабель, не изгибать кабель.

 Использование прибора в пруду допускается, если прибор установлен в соответствии с данной инструкцией. Для защиты от контактного напряжения рекомендуется использовать автоматический предохранительный выключатель с номинальным током до 30 мА. Для его установки обратитесь к специалисту!

 Данный насос не предназначен для пользования лицами (включая детей) с ограниченными психическими, сенсорными или умственными способностями, или с отсутствием опыта и/или отсутствием знаний, за исключением случая, когда за ними наблюдает ответственное за безопасность лицо, или получившими от него указания, как использовать этот насос. Дети должны быть под наблюдением, чтобы не допустить возможности для детей играть насосом.

  20 cm |  Магнитные поля этих устройств могут привести к электронным или механическим помехам или повреждениям. Это касается в т.ч. кардиостимуляторов. Соответствующие безопасные дистанции указаны в руководствах к этим медицинским приборам.

 При проведении технического обслуживания существует опасность придавливания пальцев из-за высоких магнитных усилий.

 Данное изделие не выбрасывать с обычным домашним мусором. Сдайте изделие в местный пункт сбора и утилизации.

Продукт апробирован соответственно соответствующим национальным и соответствует нормам ЕС.



**Универсальный насос 1048019 - 1048209**  
- предназначен для использования на открытом воздухе -  
модель: см. указание на корпусе насоса

**Принцип работы**

- A** ① Корпус электродвигателя ② Монтажная плита ③ Штуцер насоса с напорной стороны ④ Ротор ⑤ Крышка насоса с резиновым кольцом ⑥ Губка ⑦ Всасывающая решетка ⑧ Штуцер насоса со стороны всасывания ⑨ Заглушка.

Насос предназначен для эксплуатации как в воде, так и на суше. Насос не обладает функцией самовсасывания, поэтому при наружном использовании насос должен располагаться ниже уровня поверхности воды.

**Пуск**

Для запуска насоса всасывать воду через напорный шланг до тех пор,

пока вода не начнет поступать в насос. Только после этого подключите насос к электродвигателю. Шум от вибрации насоса в течение короткого времени – нормальное явление. Т.к. насос может эксплуатироваться на открытом воздухе, он снабжен 10-метровым резиновым электрокабелем.

Существует несколько вариантов эксплуатации насоса: а) при эксплуатации насоса вне воды используется штуцер со стороны всасывания, соединенный со шлангом; б) эксплуатация насоса в воде допускается только при наличии предварительного фильтра: для этого вывинтите штуцер со стороны всасывания, а отверстие закройте заглушкой.

С напорной стороны можно установить: а) штуцер для подсоединения напорного шланга или б) адаптер для подъемной трубки.

**В/С** Монтажную плиту по желанию можно установить с любой стороны насоса.

### Уход и обслуживание

**D/E** Выньте вилку шнура питания из розетки. Снимите всасывающую решетку и промойте губку в проточной воде.

При эксплуатации насоса в сильно загрязненной воде, губку необходимо часто менять. Сильное загрязнение насоса с напорной или всасывающей стороны приводит к появлению шумов, возникновение которых свидетельствует о необходимости тщательной очистки насоса.

Снимите крышку насоса (рис. **D**). Извлеките части насоса, как показано на рисунке (**A**). Очистите все части насоса с помощью ершиков фирмы ENEIM, как показано на рисунке **E** (арт.№ 4009570), промойте в проточной воде и соберите в обратной последовательности.

## Насос-фонтан 3148010 - 3148200

модель: см. указание на корпусе насоса

### Принцип работы

**F** ① Насос в комплекте с губкой-фильтром ② Заглушка ③ Адаптер ④ Подъемная трубка ⑤ Форсунка фонтана.

Насос всасывает воду через предварительный фильтр. Адаптер с напорной стороны предназначен для подсоединения подъемной трубки фонтана. Вставьте подъемную трубку в адаптер и наденьте форсунку.

### 6 Аксессуары













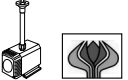

Между адаптером и подъемной трубкой можно установить Т-образный распределительный клапан (арт.№ 3052400), позволяющий регулировать высоту фонтана. Кроме того, можете использовать переходник для шлангов (арт.№ 4003940 или 4004940).

**G** Очистка форсунки фонтана: см. рисунок

## Универсальный насос для воды 1048019 - 1048209 - предназначен для использования на открытом воздухе -

модель: см. указание на корпусе насоса

Аналогичен насосу 1048019 с 1,7-метровым ПВХ-кабелем. Не предназначен для эксплуатации на открытом воздухе, в плавательных бассейнах и садовых прудах.

							
<b>Typ</b>		<b>1048</b>		<b>1048</b>		<b>3148</b>	
<b>No.</b>		1048019 - 1048209		1048219 - 1048499		3148010 - 3148200	
		<b>No.</b>		<b>No.</b>		<b>No.</b>	
230 V/50 Hz		1048019	10 m	1048219	1,5 m	3148010	10 m
				1048229	1,5 m		
				-	1048249		
100 V/50 Hz		-	-	1048289	2,0 m	-	-
100 V/60 Hz		-	-	1048329	2,0 m	-	-
120 V/60 Hz		-	-	1048319	2,0 m	3148090	5 m
240 V/50 Hz		1048119	3 m	-	-	-	-
		1048129	5 m	-	-	-	-
24 V/50 Hz		1048139	5 m	1048389	1,5 m	-	-
Abmessungen: H x B x T 115 x 147 x 75 mm Dimensions: h x l x w 4.5 x 5.8 x 3.0 in. Dimensions: haut. x larg. x prof. Afmetingen: h x l x b Måttuppgifter: h x b x d Dimensioni: alt. x larg. x prof.						336 x 120 x 75 mm 13.2 x 4.7 x 3.0 in.	
Schlauchanschluss, Saugseite Threaded adaptor, suction side Embout fileté, coté aspiration Slangpilaar, zuigzijde Anslutningsstuds, inlopp Bocchettone filettato di aspirazione				Ø 13 mm / G 3/8'' Ø 0.5 in. / G 3/8''		G 3/8''	
Schlauchanschluss, Druckseite Threaded adaptor, pressure side Embout fileté, coté pression Slangpilaar, drukzijde Anslutningsstuds, utlopp Bocchettone filettato di mandata				Ø 13 mm / G 1/4'' Ø 0.5 in. / G 1/4''		G 1/4''	
Pumpenleistung Pump output Débit de la pompe Pompcapaciteit Pumpkapacitet Potenza della pompa				600 l/h 132 Imp. gal./h 159 U.S. gal./h			
Förderhöhe H <sub>max</sub> Delivery head wat. col. Hauteur de réf. m col. d'eau Opvoerhoogte m/wk Lyfthöjd m/vst Prevalenza m/ca				1,5 m 4 ft. / 11 in.			
Leistungsaufnahme Power consumption Consumation de courant Stroomverbruik Eleffekt Assorbimento				10 W			

Vervielfältigungen oder Kopien – auch auszugsweise –  
nur mit ausdrücklicher Genehmigung des Herstellers.

Reproduction or copying – even parts thereof –  
only with the express permission of the producer.

Les reproductions, copies et utilisations de nos logos et  
matériels et produits dérivés sont interdits à l'exploitation,  
de toute nature, et sont soumises au préalable, par écrit,  
au consentement et à l'approbation du fabricant.



**EHEIM GmbH & Co. KG**  
Plochinger Str. 54  
73779 Deizisau  
Germany  
Tel. +49 7153/70 02-01  
Fax +49 7153/70 02-174



**Müller + Pflieger  
GmbH & Co. KG**  
Industriegebiet  
Kreuzwiese 13  
67806 Rockenhausen  
Germany  
Tel. +49 6361/9 21 60  
Fax +49 6361/76 44



**Eugen Jäger GmbH**  
Auf dem Berg 31  
71543 Wüstenrot  
Germany  
Tel. +49 7945/633  
Fax +49 7945/13 61

[www.eheim.de](http://www.eheim.de)